

INSTALLATION INSTRUCTIONS

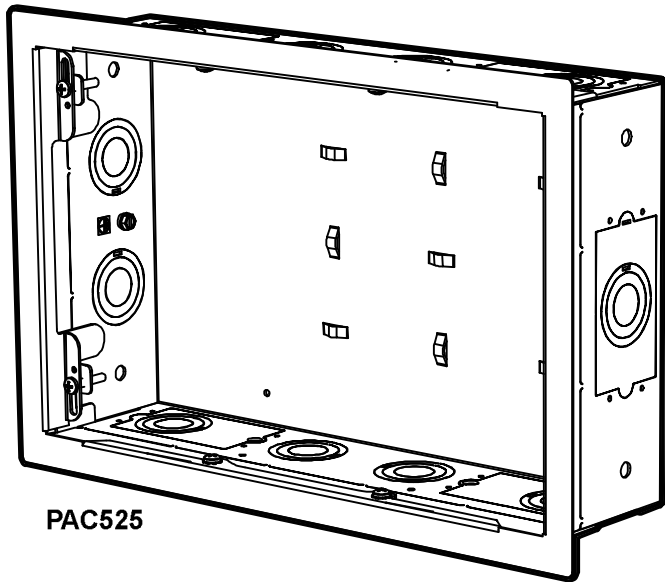

PAC525

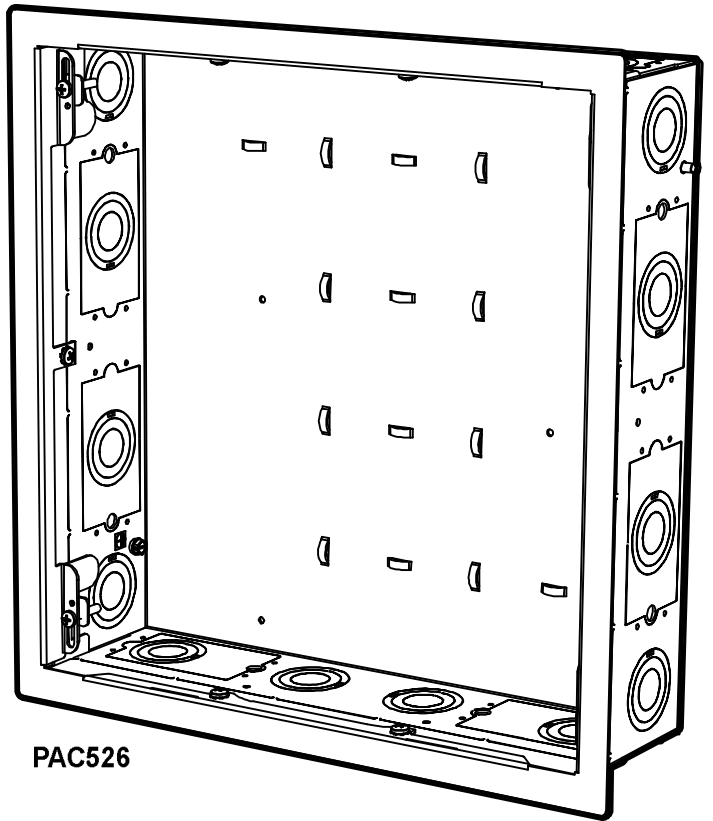

PAC526

In-Wall Accessory Boxes

DISCLAIMER

Milestone AV Technologies and its affiliated corporations and subsidiaries (collectively "Milestone"), intend to make this manual accurate and complete. However, Milestone makes no claim that the information contained herein covers all details, conditions or variations, nor does it provide for every possible contingency in connection with the installation or use of this product. The information contained in this document is subject to change without notice or obligation of any kind. Milestone makes no representation of warranty, expressed or implied, regarding the information contained herein. Milestone assumes no responsibility for accuracy, completeness or sufficiency of the information contained in this document.

Chief® is a registered trademark of Milestone AV Technologies. All rights reserved.

IMPORTANT SAFETY INSTRUCTIONS



WARNING: A WARNING alerts you to the possibility of serious injury or death if you do not follow the instructions.



CAUTION: A CAUTION alerts you to the possibility of damage or destruction of equipment if you do not follow the corresponding instructions.



WARNING: Failure to read, thoroughly understand, and follow all instructions can result in serious personal injury, damage to equipment, or voiding of factory warranty! It is the installer's responsibility to make sure all components are properly assembled and installed using the instructions provided.



WARNING: Failure to provide adequate structural strength for this accessory can result in serious personal injury or damage to equipment! It is the installer's responsibility to make sure the structure to which this accessory is attached can support five times the combined weight of all equipment.



WARNING: Exceeding the weight capacity can result in serious personal injury or damage to equipment! It is the installer's responsibility to make sure the combined weight of all components located in the accessory does not exceed 10 lbs (4.5 kg).



WARNING: Use this mounting system only for its intended use as described in these instructions. Do not use attachments not recommended by the manufacturer.



WARNING: For indoor use only.

IMPORTANT ! : The PAC525/526 mounts are designed to be mounted to a 2" x 4" wood stud wall 16" on center, a 2" x 4" -25ga (minimum) steel studs wall, or to a 1/2" minimum thickness drywall surface.

NOTE: Spacings - Minimum spacings between the 120 Vac power components and the A/V components shall be maintained for safe operation of the equipment when installed in accordance with the National Electric Code, ANSI/NFPA 70.

NOTE: When selecting a Listed 120 Vac Receptacle for use as the main power source for the PAC Series boxes (to power the A/V equipment), make sure that AC Receptacle is rated at least 15A and it is used in the building's AC branch circuit that is connected to a circuit breaker rated at least 15A. Do not connect more than 12A from the Receptacle.

In the U.S., the equipment shall be installed per the applicable requirements of the National Electrical Code, ANSI/NFPA 70.

In Canada, the equipment shall be installed per the applicable requirements of the Canadian Electrical Code, CSA C22.1.

NOTE: It is the installer's responsibility to ensure that the enclosure is bonded to the ground in the switch box, in accordance with the National Electric Code, ANSI/NFPA 70 or Canadian Electrical Code, CSA C22.1. A green grounding screw is provided in the enclosure for the purpose, if required.

--SAVE THESE INSTRUCTIONS--

DIMENSIONS



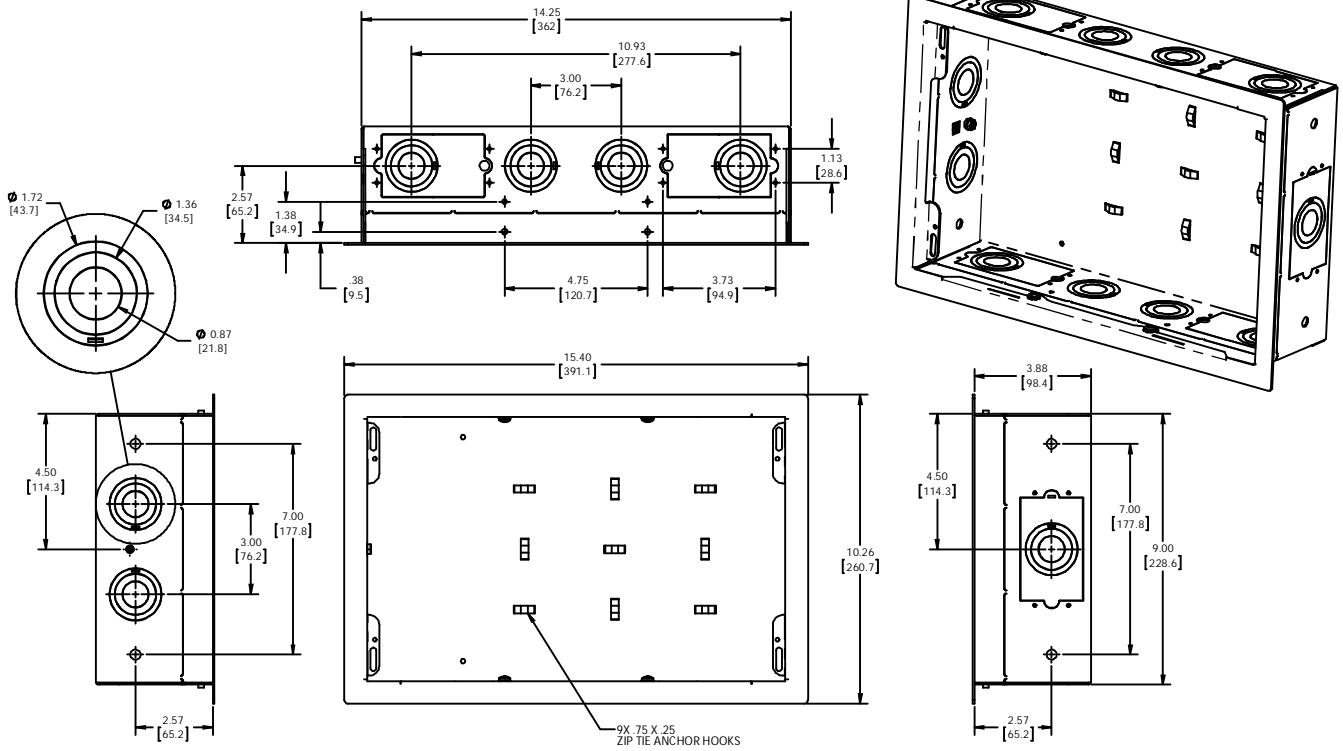



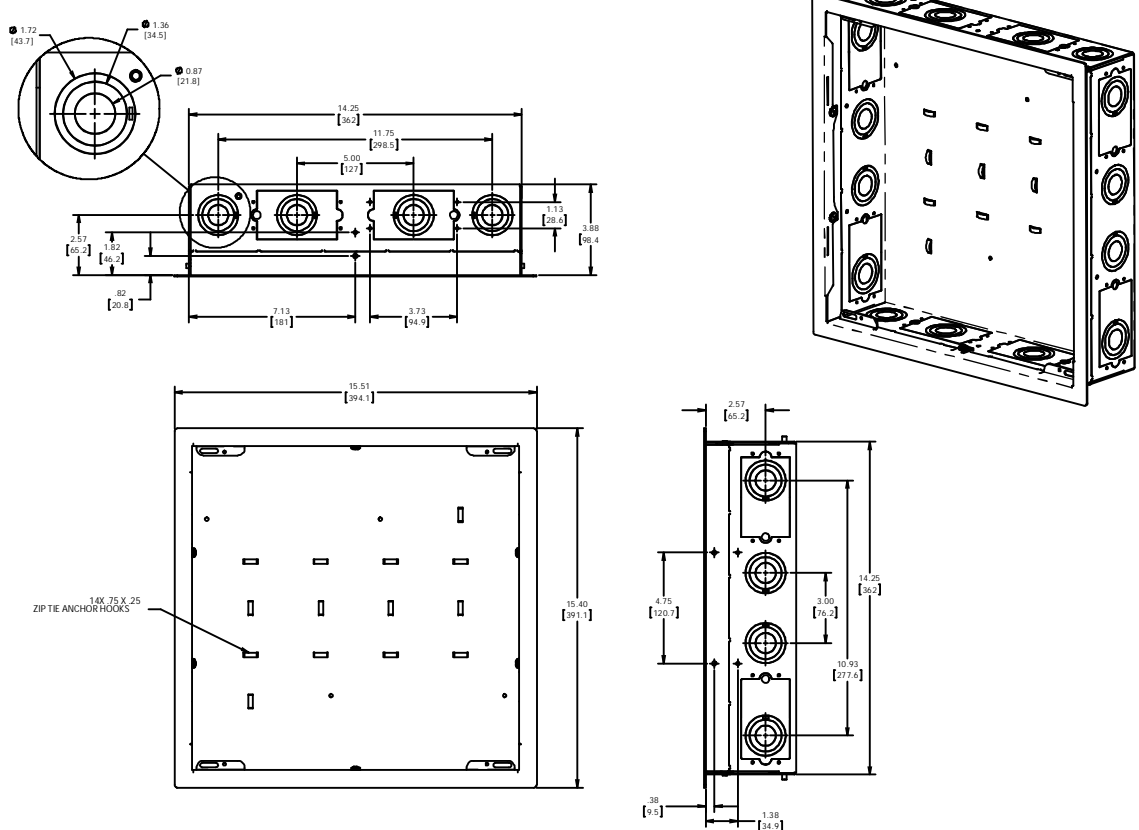

PAC525

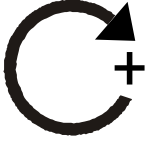

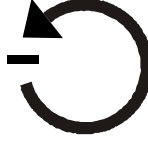
PAC526

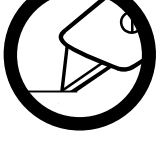

LEGEND

	<table border="1"> <thead> <tr> <th>Tighten Fastener</th> </tr> </thead> <tbody> <tr><td>Apretar elemento de fijación</td></tr> <tr><td>Befestigungsteil festziehen</td></tr> <tr><td>Apertar fixador</td></tr> <tr><td>Serrare il fissaggio</td></tr> <tr><td>Bevestiging vastdraaien</td></tr> <tr><td>Serrez les fixations</td></tr> </tbody> </table>	Tighten Fastener	Apretar elemento de fijación	Befestigungsteil festziehen	Apertar fixador	Serrare il fissaggio	Bevestiging vastdraaien	Serrez les fixations		<table border="1"> <thead> <tr> <th>Pencil Mark</th> </tr> </thead> <tbody> <tr><td>Marcar con lápiz</td></tr> <tr><td>Stiftmarkierung</td></tr> <tr><td>Marcar com lápis</td></tr> <tr><td>Segno a matita</td></tr> <tr><td>Potloodmerkten</td></tr> <tr><td>Marquage au crayon</td></tr> </tbody> </table>	Pencil Mark	Marcar con lápiz	Stiftmarkierung	Marcar com lápis	Segno a matita	Potloodmerkten	Marquage au crayon
Tighten Fastener																	
Apretar elemento de fijación																	
Befestigungsteil festziehen																	
Apertar fixador																	
Serrare il fissaggio																	
Bevestiging vastdraaien																	
Serrez les fixations																	
Pencil Mark																	
Marcar con lápiz																	
Stiftmarkierung																	
Marcar com lápis																	
Segno a matita																	
Potloodmerkten																	
Marquage au crayon																	
	<table border="1"> <thead> <tr> <th>Loosen Fastener</th> </tr> </thead> <tbody> <tr><td>Alojar elemento de fijación</td></tr> <tr><td>Befestigungsteil lösen</td></tr> <tr><td>Desapertar fixador</td></tr> <tr><td>Allentare il fissaggio</td></tr> <tr><td>Bevestiging losdraaien</td></tr> <tr><td>Desserrez les fixations</td></tr> </tbody> </table>	Loosen Fastener	Alojar elemento de fijación	Befestigungsteil lösen	Desapertar fixador	Allentare il fissaggio	Bevestiging losdraaien	Desserrez les fixations		<table border="1"> <thead> <tr> <th>Drill Hole</th> </tr> </thead> <tbody> <tr><td>Perforar</td></tr> <tr><td>Bohrloch</td></tr> <tr><td>Fazer furo</td></tr> <tr><td>Praticare un foro</td></tr> <tr><td>Gat boren</td></tr> <tr><td>Percez un trou</td></tr> </tbody> </table>	Drill Hole	Perforar	Bohrloch	Fazer furo	Praticare un foro	Gat boren	Percez un trou
Loosen Fastener																	
Alojar elemento de fijación																	
Befestigungsteil lösen																	
Desapertar fixador																	
Allentare il fissaggio																	
Bevestiging losdraaien																	
Desserrez les fixations																	
Drill Hole																	
Perforar																	
Bohrloch																	
Fazer furo																	
Praticare un foro																	
Gat boren																	
Percez un trou																	
	<table border="1"> <thead> <tr> <th>Phillips Screwdriver</th> </tr> </thead> <tbody> <tr><td>Destornillador Phillips</td></tr> <tr><td>Kreuzschlitzschraubendreher</td></tr> <tr><td>Chave de fendas Phillips</td></tr> <tr><td>Cacciavite a stella</td></tr> <tr><td>Kruiskopschroevendraaier</td></tr> <tr><td>Tournevis à pointe cruciforme</td></tr> </tbody> </table>	Phillips Screwdriver	Destornillador Phillips	Kreuzschlitzschraubendreher	Chave de fendas Phillips	Cacciavite a stella	Kruiskopschroevendraaier	Tournevis à pointe cruciforme		<table border="1"> <thead> <tr> <th>Adjust</th> </tr> </thead> <tbody> <tr><td>Ajustar</td></tr> <tr><td>Einstellen</td></tr> <tr><td>Ajustar</td></tr> <tr><td>Regolare</td></tr> <tr><td>Afstellen</td></tr> <tr><td>Ajuster</td></tr> </tbody> </table>	Adjust	Ajustar	Einstellen	Ajustar	Regolare	Afstellen	Ajuster
Phillips Screwdriver																	
Destornillador Phillips																	
Kreuzschlitzschraubendreher																	
Chave de fendas Phillips																	
Cacciavite a stella																	
Kruiskopschroevendraaier																	
Tournevis à pointe cruciforme																	
Adjust																	
Ajustar																	
Einstellen																	
Ajustar																	
Regolare																	
Afstellen																	
Ajuster																	
	<table border="1"> <thead> <tr> <th>Flathead Screwdriver</th> </tr> </thead> <tbody> <tr><td> </td></tr> <tr><td> </td></tr> <tr><td> </td></tr> <tr><td> </td></tr> <tr><td> </td></tr> <tr><td> </td></tr> </tbody> </table>	Flathead Screwdriver								<table border="1"> <thead> <tr> <th>Remove</th> </tr> </thead> <tbody> <tr><td>Quitar</td></tr> <tr><td>Entfernen</td></tr> <tr><td>Remover</td></tr> <tr><td>Rimuovere</td></tr> <tr><td>Verwijderen</td></tr> <tr><td>Retirez</td></tr> </tbody> </table>	Remove	Quitar	Entfernen	Remover	Rimuovere	Verwijderen	Retirez
Flathead Screwdriver																	
Remove																	
Quitar																	
Entfernen																	
Remover																	
Rimuovere																	
Verwijderen																	
Retirez																	
	<table border="1"> <thead> <tr> <th>Mark level line</th> </tr> </thead> <tbody> <tr><td> </td></tr> <tr><td> </td></tr> <tr><td> </td></tr> <tr><td> </td></tr> <tr><td> </td></tr> <tr><td> </td></tr> </tbody> </table>	Mark level line								<table border="1"> <thead> <tr> <th>Precision hand cut surface</th> </tr> </thead> <tbody> <tr><td> </td></tr> <tr><td> </td></tr> <tr><td> </td></tr> <tr><td> </td></tr> <tr><td> </td></tr> <tr><td> </td></tr> </tbody> </table>	Precision hand cut surface						
Mark level line																	
Precision hand cut surface																	

TOOLS REQUIRED FOR INSTALLATION

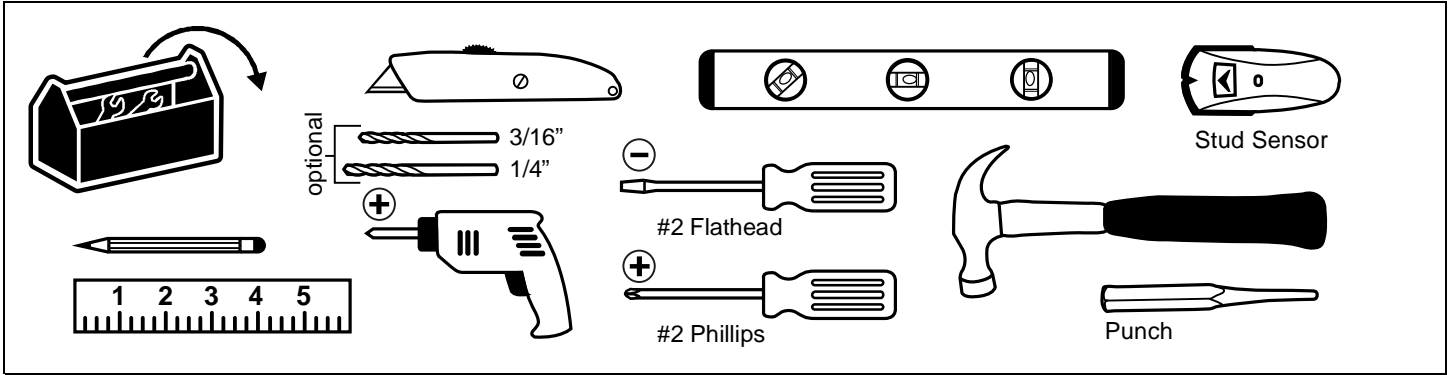

PARTS INCLUDED

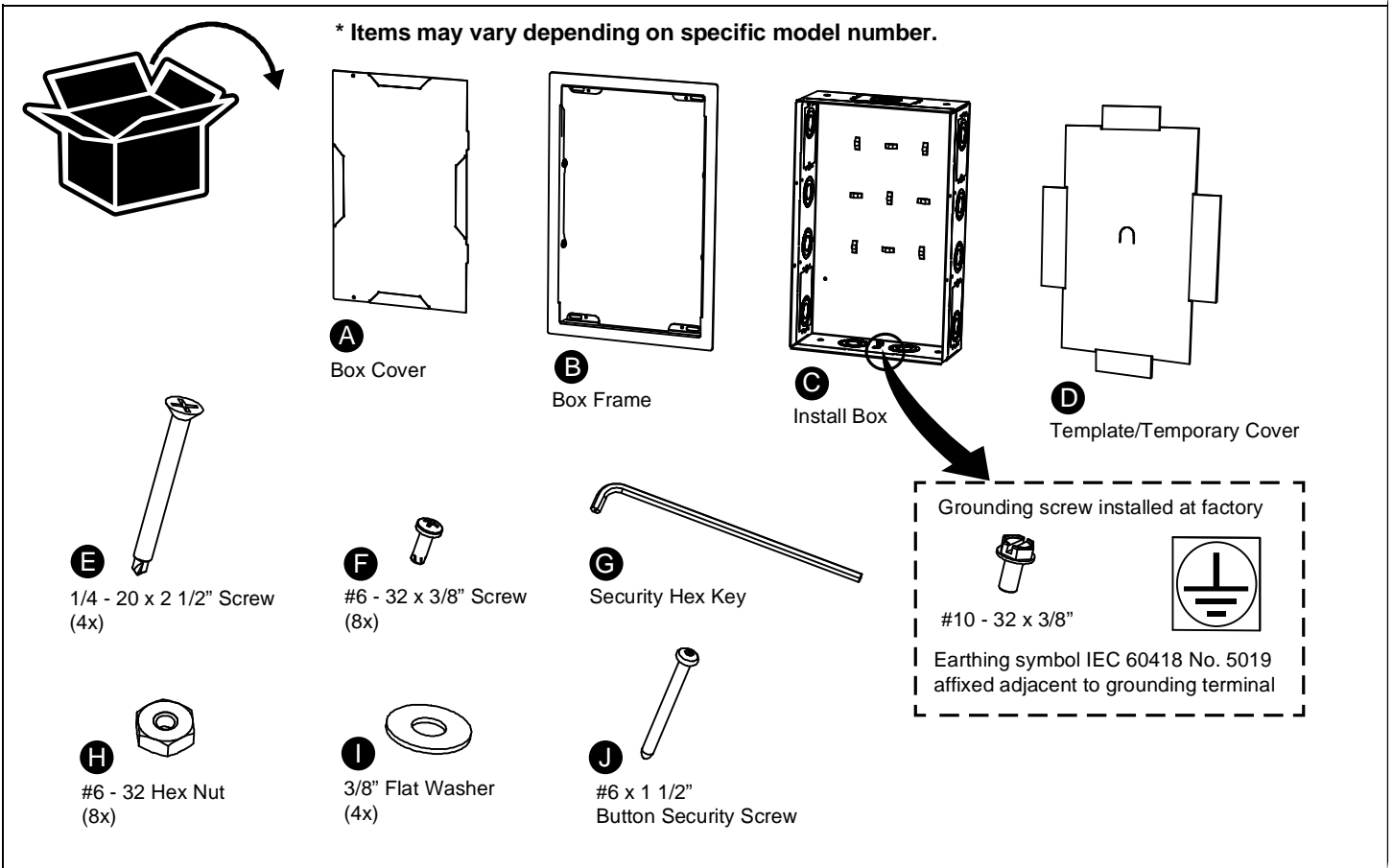

OPTIONAL PARTS PER CUSTOM CONFIGURATION (NOT INCLUDED)

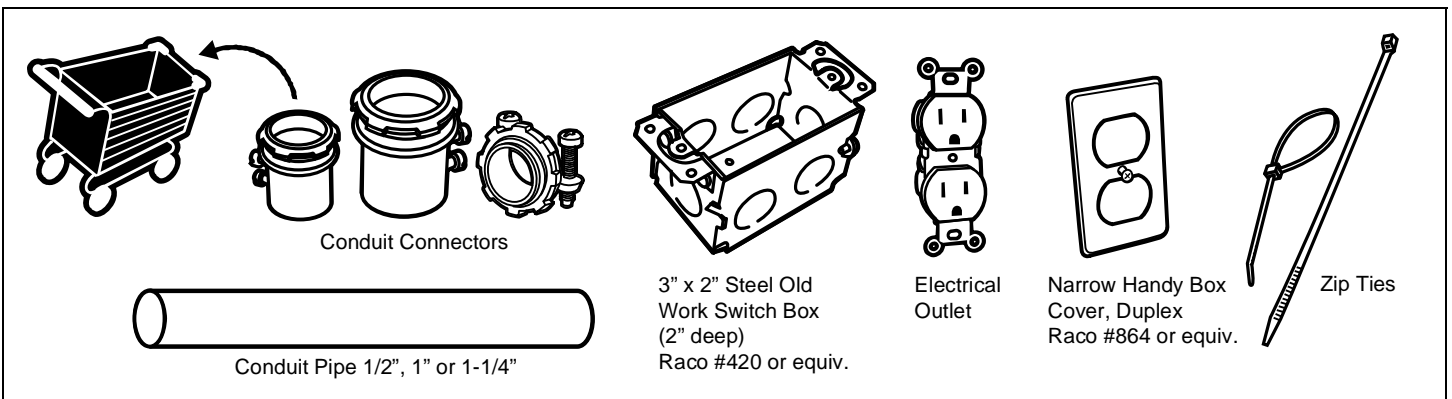

INSTALLATION

The PAC525/526 is intended for use both in installations where an existing finished drywall wall is present, and where the wall surface has not been finished and the structural studs are exposed. The wall then must be finished around the opening of the box after the box has been installed.



WARNING: All wiring should be performed by a licensed electrician following all local codes and ordinances.

PAC525/526 Project Planning

- ① Identify a suitable wall location for the accessory.
- ② Using a stud sensor, locate and mark studs.
- ③ Identify possible structural conflicts (electrical wiring, plumbing, gaslines, HVAC).



WARNING: ELECTRICAL SHOCK HAZARD! CUTTING OR DRILLING INTO ELECTRICAL WIRES OR CABLES CAN CAUSE DEATH OR SERIOUS PERSONAL INJURY! ALWAYS make certain area behind mounting surfaces is free of electrical wires and cables before cutting, drilling or installing fasteners.



WARNING: EXPLOSION AND FIRE HAZARD! CUTTING OR DRILLING INTO GAS PLUMBING CAN CAUSE DEATH OR SERIOUS PERSONAL INJURY. ALWAYS make certain area behind mounting surfaces is free of gas, water, waste or any other plumbing before cutting, drilling or installing fasteners.

- ④ Determine installation type. Housing is designed to fit between two adjacent wall studs, or onto a 1/2" minimum thickness drywall surface.

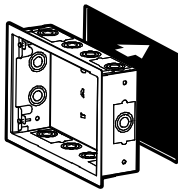

Drywall attachment only

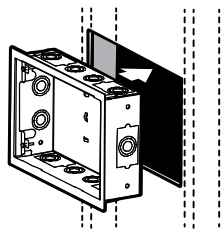

Stud & drywall attachment

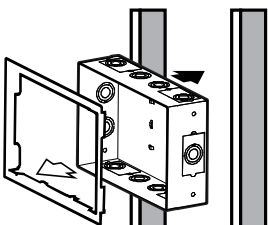

Pre-sheetrock attachment

- ⑤ Plan box and component needs. Sketch diagrams provided:

PAC525

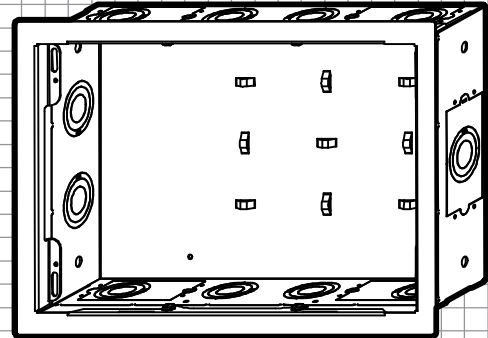

PAC526

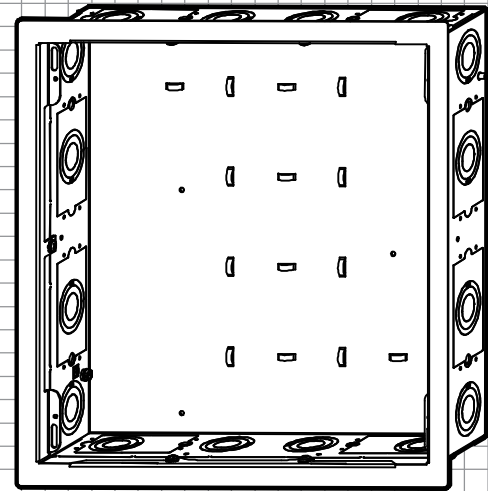

- ⑥ Determine all components needed.

- Conduit Pipe
- Conduit Connectors (large and small)
- Electrical Box(es) (3" x 2")
- Steel Electrical Box Cover(s)
- Zip Ties
- Electrical Outlet(s)

PAC525/526 Site Preparation

- ⑦ Using a level, draw a horizontal line at lower edge of install site.
A - STUD ATTACHMENT - create exploratory hole to confirm edge of stud/studs.
B - DRYWALL ATTACHMENT - mark horizontal cut locations ensuring a minimum 1/2" distance from each stud.

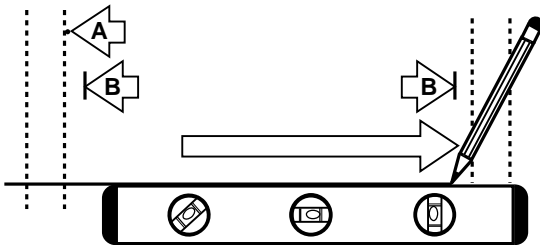

- ⑧ Align on lower edge drawn line (A) and horizontal marking for inside stud location (B). Use enclosed template or housing as a template, drawing line around top and sides of housing.

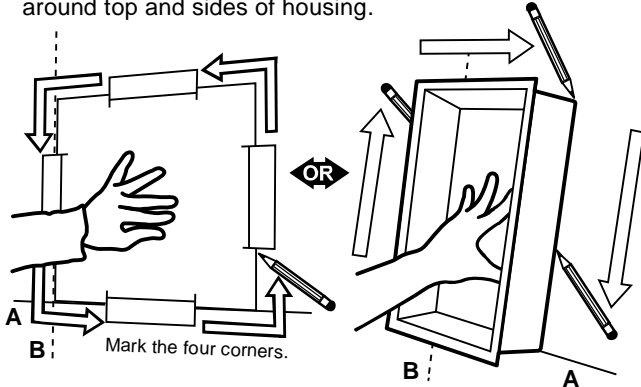

- ⑨ Cut along outside edge of line using utility knife. Remove drywall.
 NOTE:
 Cutting past corners weakens the cleats' ability to hold securely.

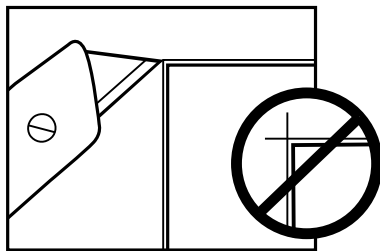

PAC525/526 Box Preparation

- ⑪ Remove knock-outs in box as predetermined in step 5.

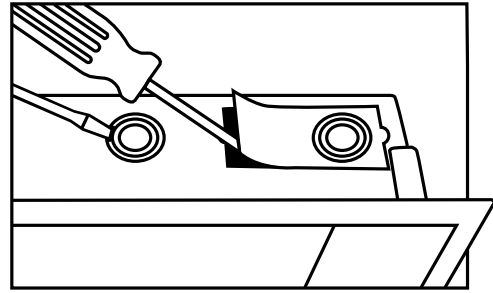

- ⑫ Loosely attach components and conduit (cut to length) to box to ease fitting into wall opening.

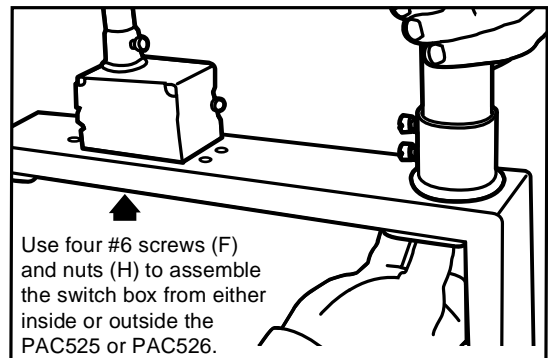

PAC525/526 Box Installation

- ⑬ Feed attached conduit through cut-out and insert box into opening in wall. Tighten component connections.

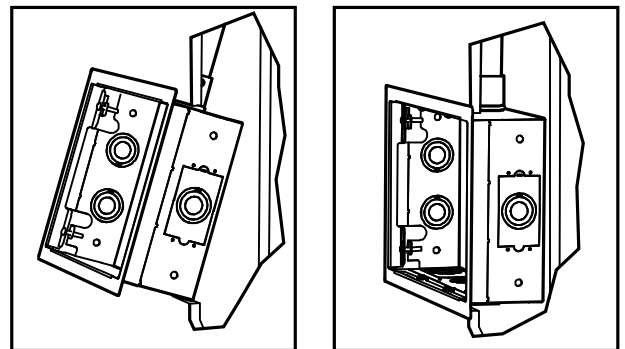

- ⑩ Once wall opening is completed, check stud depth. If 3.5" or greater, proceed to step 11. If **less than 3.5" deep**, modify depth of box as follows before proceeding: **CAUTION:** Injury may occur on sharp edges. Carefully discard the removable tabs.

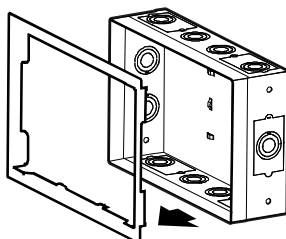
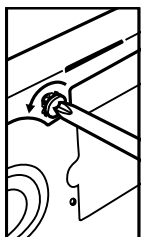

A - Remove box flange by removing screws.

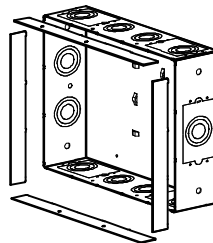

B - Snap off removable tabs at perforations provided.

CAUTION:
 Avoid sharp edges.

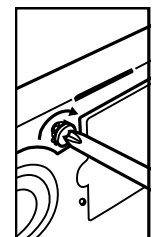
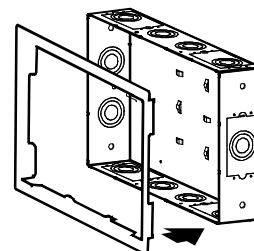

C - Reinstall box flange. Reattach screws.

- 14 Secure box into place by methods chosen.

DRYWALL ATTACHMENT:
Slide locking cleats into place. Tighten screws to secure.

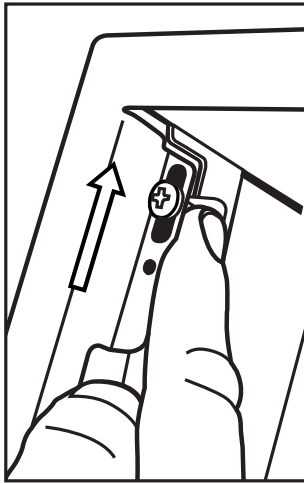

STUD ATTACHMENT:

Drill pilot holes (optional) into studs through mounting holes in box. Wood studs - use 3/16" bit. If steel studs - use 1/4" bit. Install with 1/4 - 20 x 2 1/2" screws (E) and 3/8" flat washers (I) into pilot holes.

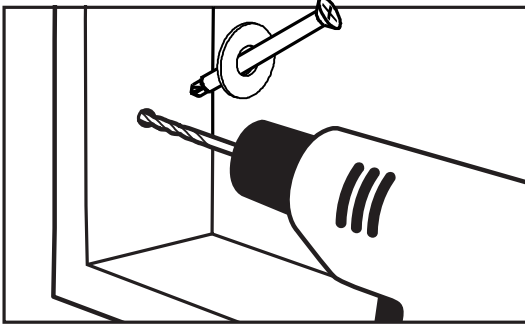

- 15 **NOTE:**
Box may be installed with outer flange removed for a pre-sheetrock open stud mount configuration.

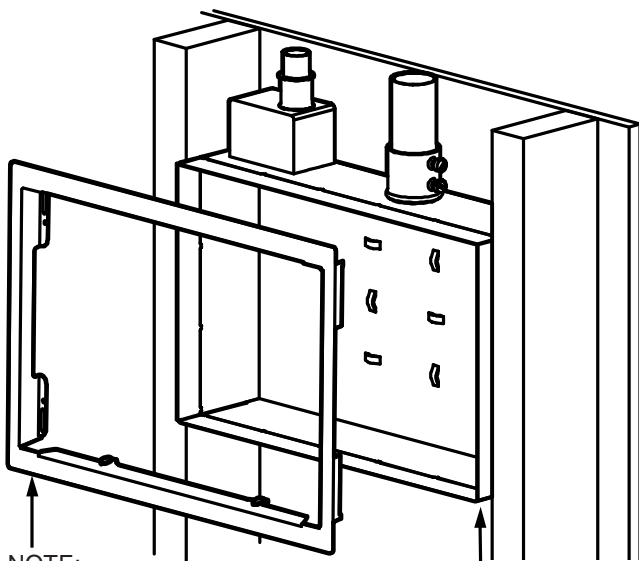

NOTE:
Save flange for reattachment after sheetrock is installed.

NOTE:
Locate front edge of box extended beyond studs by thickness of sheetrock to be used.

PAC525/526 Final Finishing

- 16 Using preferred attachment method (zip ties, bands, etc. - none included), secure AV components and cables within the wall box. Attachment methods may use integrated attachment points at back of wall box or other appropriate points.

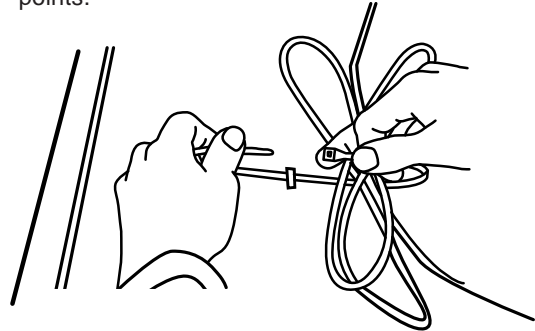

- 17 Install template as temporary cover if needed to protect from debris by folding tabs in and inserting into opening.

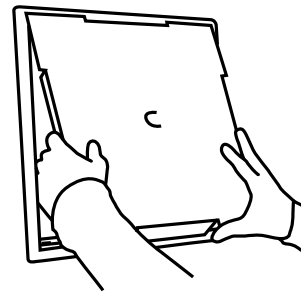

- 18 Modify enclosure cover before attaching. Break away tab(s) to allow wire exit from box and meet ventilation needs.

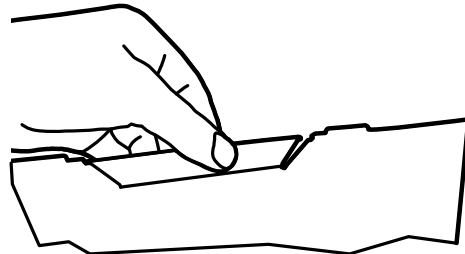

- 19 Gather wires and route through cover opening. Install cover, screw fasteners(2) into place to secure and complete enclosure.

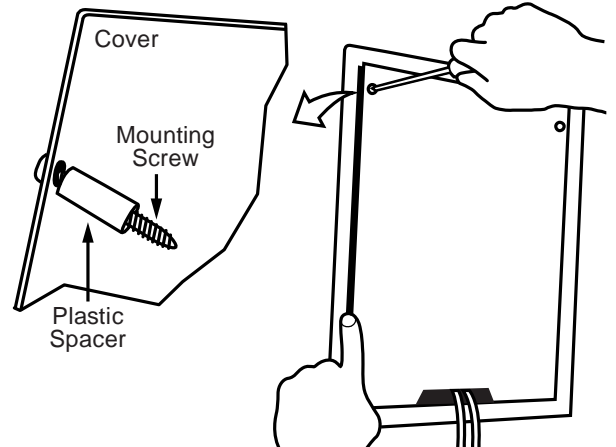



Our Mounts. **Your Vision.**

Chief, a products division of
Milestone AV Technologies

8800-002517 Rev01
©2014 Milestone AV Technologies
www.chiefmfg.com
09/14

USA/International	A 6436 City West Parkway, Eden Prairie, MN 55344 P 800.582.6480 / 952.225.6000 F 877.894.6918 / 952.894.6918
Europe	A Franklinstraat 14, 6003 DK Weert, Netherlands P +31 (0) 495 580 852 F +31 (0) 495 580 845
Asia Pacific	A Office No. 918 on 9/F, Shatin Galleria 18-24 Shan Mei Street Fotan, Shatin, Hong Kong P 852 2145 4099 F 852 2145 4477

